

CMS Power-lines Protection Series (CMS-P)

Descriptions

The Ceramic Micro-Surge Protection Device (CMS) is manufactured from semiconducting ceramics which offer rugged protection and excellent transient energy absorption in a small SMD package. These devices are designed to suppress a variety of transient events, including those specified in IEC61000-4-2, IEC61000-4-5 and other standards used for Electromagnetic Compliance (EMC).

These devices are available in ceramic leadless chip form, eliminating lead inductance and assuring fast speed of response to transient surges. In addition, The CMS transient suppressors have temperature independent suppression characteristics, affording protection from -55°C to 125°C, which is much better than suppressors based on silicon semiconductor technology.

The CMS-P Series is specially designed for power-lines protection applications. It features a very high current protection capability with a very small size, also a very fast response thus a ultra low clamping voltage. These characteristics make CMS-P Series devices the best replacement of TVS and metal oxide (MOV).

Features

- Multi-Layers Construction Provides Higher Power Dissipation
- Surge Current Capability: 200A (@8/20μs)
- Better than UL94V-0 Flammability Rating
- No Temperature Derating up to 125°C Ambient
- Reliable ESD Protection up to 30kV acc. to IEC61000-4-2
- Inherent Bi-directional Clamping
- SMD type Body size 0806
- “Zero” Lead Inductance
- Very low Clamping Voltage
- RoHS compliant

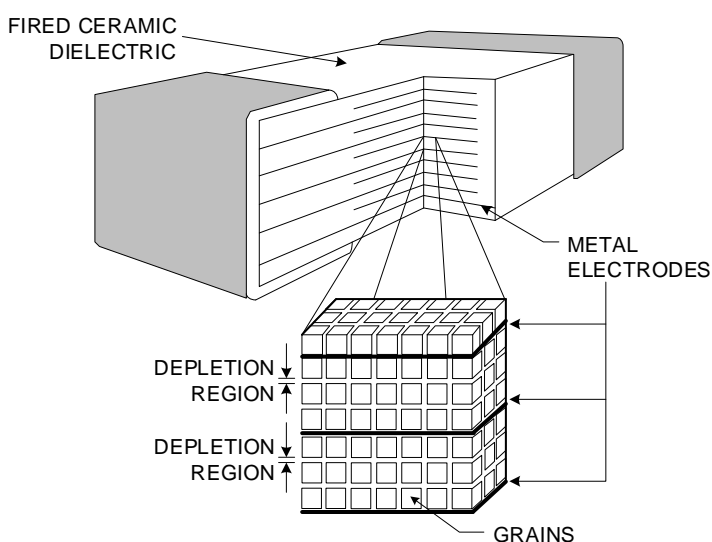

Multilayer Internal Construction

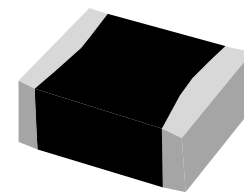

Top View (0806)

Order Information

Type	Quantity	Reel Size
CMS0806	2000pcs	7 Inch (178mm)

Applications

- Severe transient voltage suppressor for power-lines, replacing traditional MOV&TVS solutions.
- Surge protection for IEC61000-4-5
- EFT protection for IEC 61000-4-4 (Level 4)
- ESD protection for IEC 61000-4-2 (Level 4)

Device Ratings and Specifications (TA=25°C unless otherwise noted)

Parameter	Symbol	Condition	Value	Unit
Maximum Continuous a.c. Voltage	$V_{M(AC)}$	50~60Hz	25	V
Maximum Continuous d.c. Voltage	$V_{M(DC)}$		30	V
Nominal Varistor Voltage	V_N	@1mA	35.1~42.9	V
Maximum Leakage Current	I_L	@ V_M	30	μA
Maximum Clamping Voltage	V_C	@ I_C	65	V
Class Current	I_C	$t_p = 8/20\mu s$	2	A
Peak Pulse Current	I_{PP}	$t_p = 8/20\mu s$	200	A
Operating Temperature Range			-55 to +125	°C
Storage Temperature			-55 to +150	°C

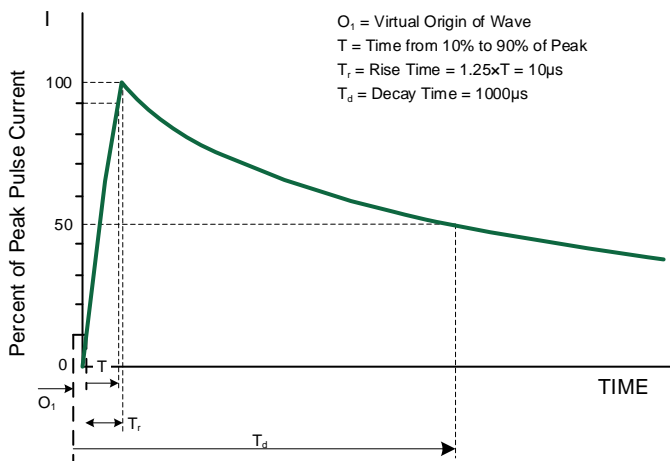
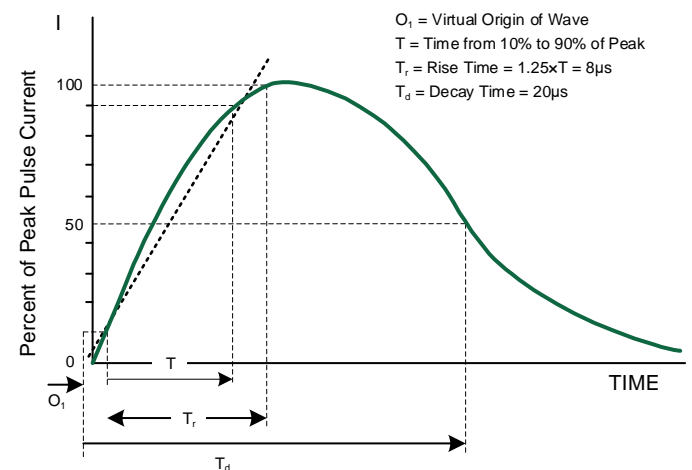
Pulse Waveform - 10/1000 μs waveform

Pulse Waveform - 8/20 μs waveform

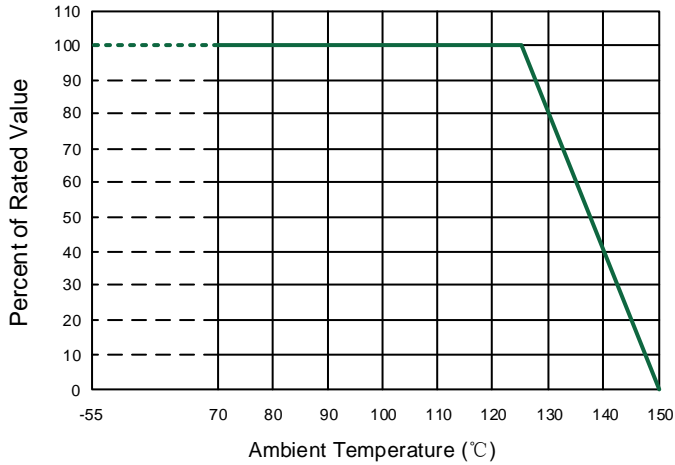
Current, Energy and Power Derating Curve

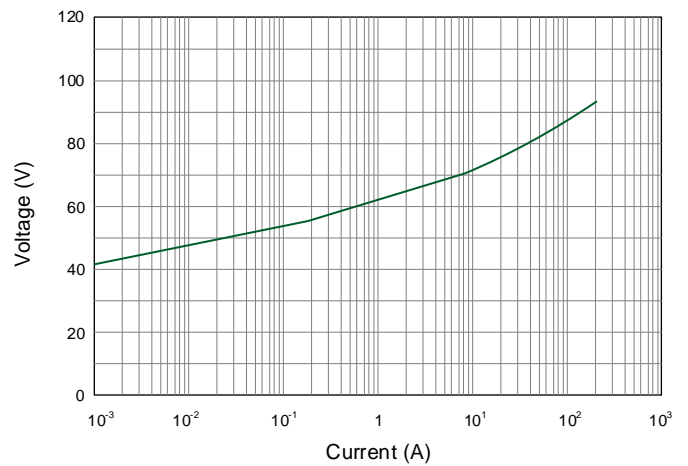

Max. Clamping Voltage



Lead-free Re-flow Solder Profile

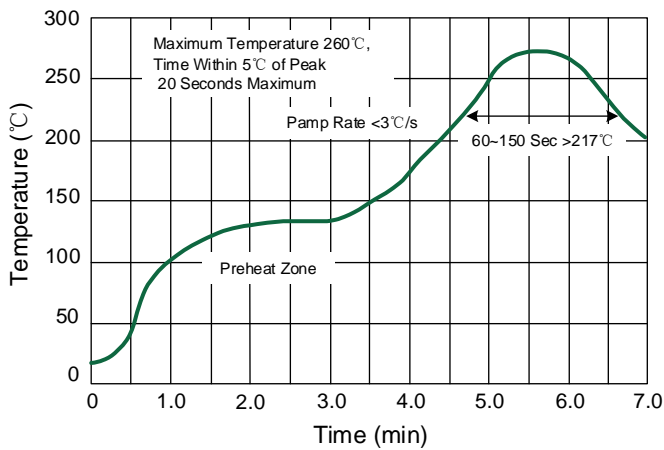

Iron Soldering Profile

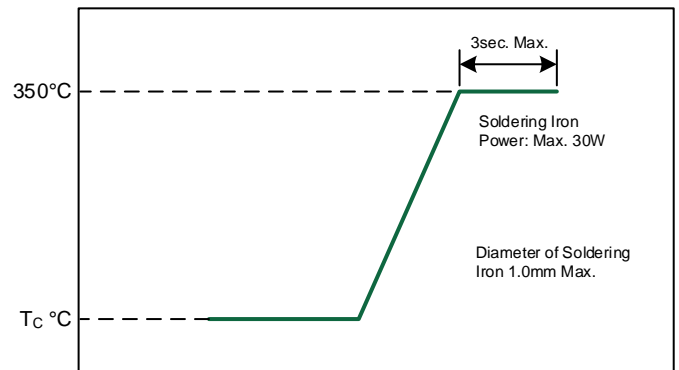

Typical Applications

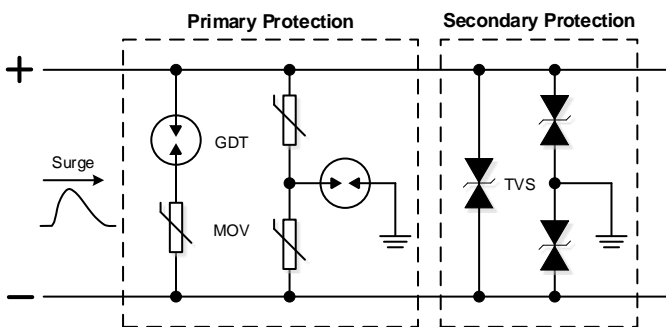

Traditional Solution of Surge Protection for Power Supply

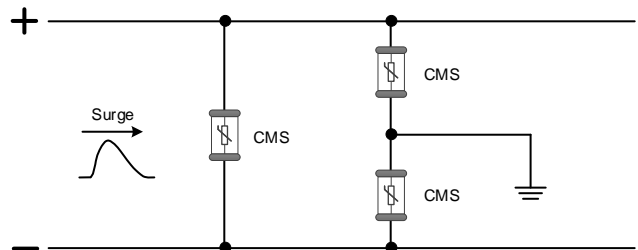

CMS Solution of Surge Protection for Power Supply

Product Dimensions

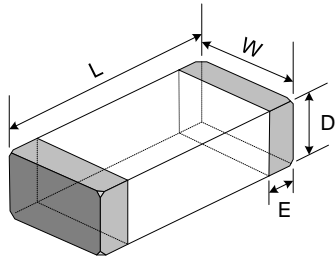
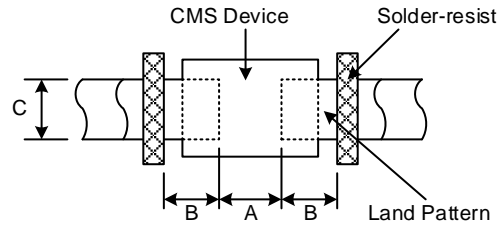
Product Dimensions

Recommended PCB Pattern

Size	L	W	D	E	A	B	C
0806	2.20+0.4/-0.20	1.6+0.4/-0.20	2.0Max.	0.15~0.75	1.2~1.6	0.8~1.2	1.6~2.0

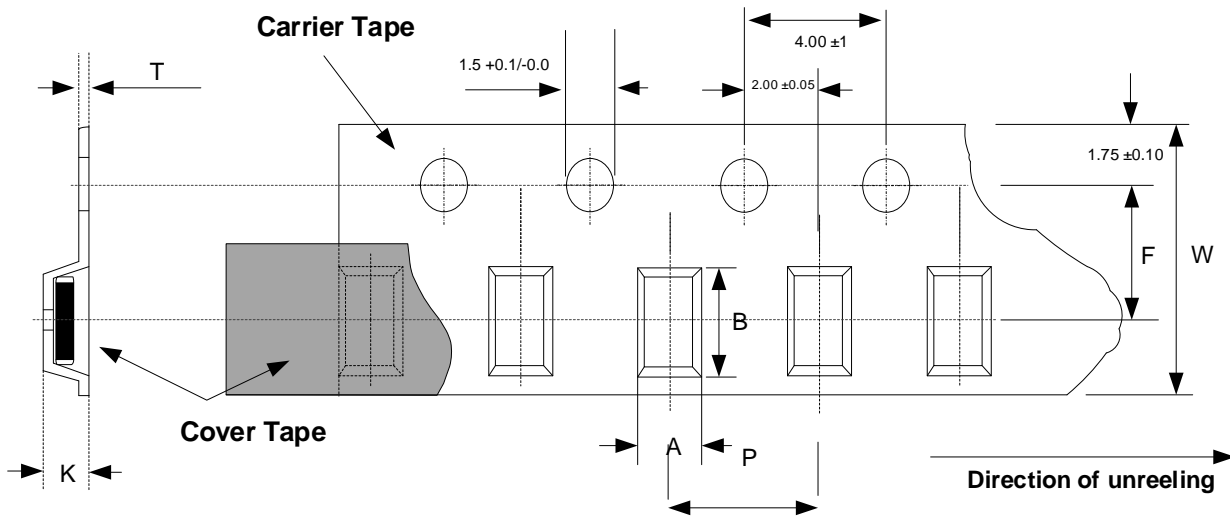
Tape Specifications



Type	A	B	K	P	W	F
CMS0806	2.10±0.2	2.50±0.2	2.2Max.	4.00 ±0.10	8.00 ±0.30	3.50 ±0.05

Reel Dimension

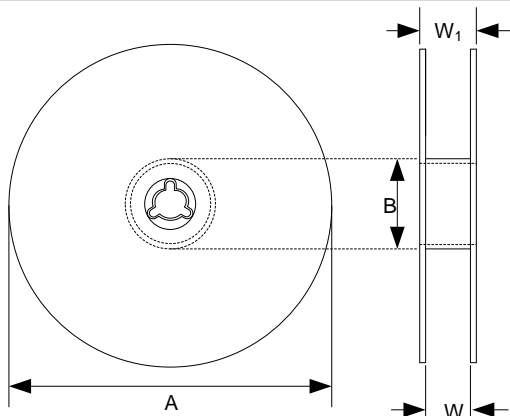

Type	Dimensions (mm)			
	A	B	W	W1
7"	178±2.0	58±2.0	8.4+1.5/-0.0	Max. 14.4

Storage

- Storage temperature range (packaging conditions): -10°C ~ $+40^{\circ}\text{C}$ RH 70% (Max.).
- The solderability of the external electrode may be deteriorated if packages are stored where they are exposed to high humidity. Package must be stored at 40°C or less and 70% RH or less.
- The solderability of the external electrode may be deteriorated if packages are stored where they are exposed to dust of harmful gas (e.g. HCl, sulfurous gas of H_2S).
- Packaging material may be deformed if package are stored where they are exposed to heat of direct sunlight.
- Solderability shall be guaranteed for 12 months from the date of delivery on condition that they are stored at the environment specified in Clause 2. For those parts, which passed more than 12 months shall be checked solder-ability before use.

Environmental Reliability Test

Item	Requirment	Test Condition
High Temperature Storage	<ul style="list-style-type: none"> • Breakdown voltage change: within $\pm 10\%$ • No mechanical damage 	<ul style="list-style-type: none"> • Temperature: $150 \pm 2^{\circ}\text{C}$ • Time: 1000 (+24) hours • Test after placing in ambient temperature for 1~2hours
Low Temperature Storage	<ul style="list-style-type: none"> • Breakdown voltage change: within $\pm 10\%$ • No mechanical damage 	<ul style="list-style-type: none"> • Temperature: $-55 \pm 2^{\circ}\text{C}$ • Time: 1000 (+24) hours • Test after placing in ambient temperature for 1~2hours
Thermal Shock	<ul style="list-style-type: none"> • Breakdown voltage change: within $\pm 10\%$ • No mechanical damage 	<ul style="list-style-type: none"> • Temperature, Time: $-55 (\pm 2)^{\circ}\text{C}/30\text{min}$~ $125 (\pm 2)^{\circ}\text{C}/30\text{min}$ • Transforming interval: 2~3min. • Tested cycle: 100 cycles. • Test after placing in ambient temperature for 1~2hours
High Temperature Load	<ul style="list-style-type: none"> • Breakdown voltage change: within $\pm 10\%$ • No mechanical damage 	<ul style="list-style-type: none"> • Temperature: $125 \pm 2^{\circ}\text{C}$ • Rated working voltage applied • Time: 1000 (+24) hours • Test after placing in ambient temperature for 1~2hours
Damp Heat Load / Humidity Load	<ul style="list-style-type: none"> • Breakdown voltage change: within $\pm 10\%$ • No mechanical damage 	<ul style="list-style-type: none"> • Temperature: $85 \pm 2^{\circ}\text{C}$ • Humidity: $85\% \pm 2\text{RH}$ • Rated working voltage applied • Time: 500 (+24) hours • Test after placing in ambient temperature for 1~2hours

© Boarden Electronics Ltd.

Specifications are subject to change without notice.

Website: www.boarden.com.cn

Tel: 86-21-61401058

Fax: 86-21-61730538